



# Quick Reference Notes – **DAILY CARE**

## 簡易操作 – **日常保養**

ApeosPort® -VII C7788 / C6688 / C5588

# CONTENTS

## 目錄

1	Clear Paper Jam 夾紙排解.....	2
2	REPLACING TONER & WASTE TONER CONTAINER	更換碳粉匣及碳粉回收盒 4
3	Extra Information 更多資訊.....	5

# 1 CLEAR PAPER JAM 夾紙排解

## i. Document Feeder / 送稿器

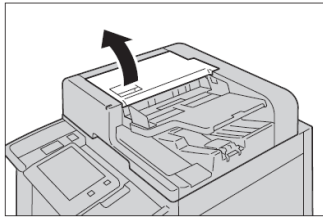

1

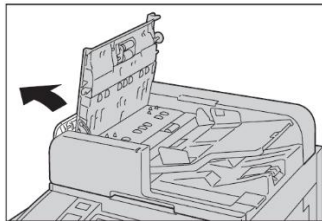

2

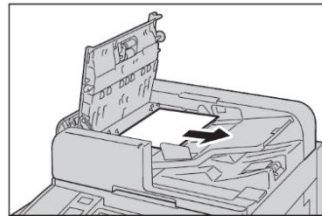

3

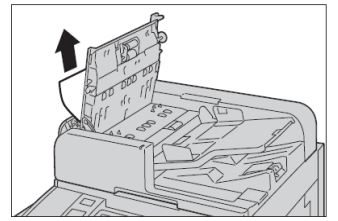

4

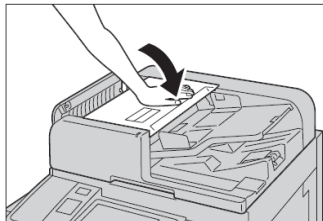

5

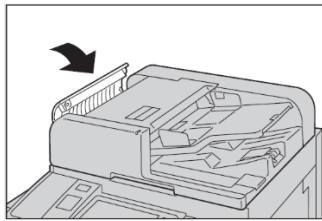

6

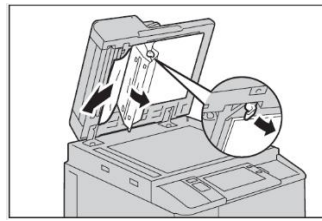

7

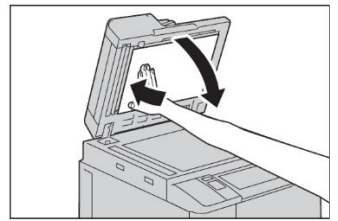

8

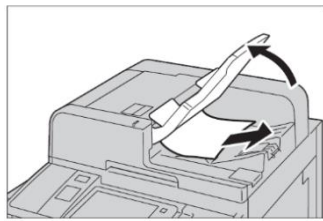

9



Scan QR Code OR Click [here](#) for online version of this chapter  
請掃描 QR Code 或者點擊 [這裡](#) 查看本章的網上版本

For more online support information please visit  
更多相關資料，請訪問以下網址：

<https://support-fb.fujifilm.com>

## ii. Tray 5 (Bypass) / 紙盤 5 (手送紙盤)

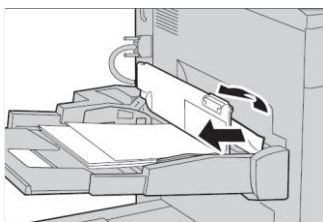

1

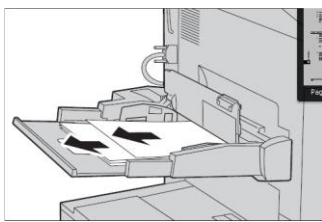

2

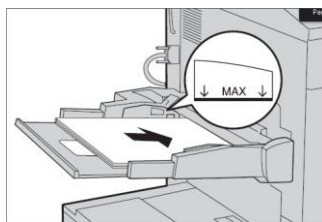

3

iii. Transfer Module / 轉印裝置

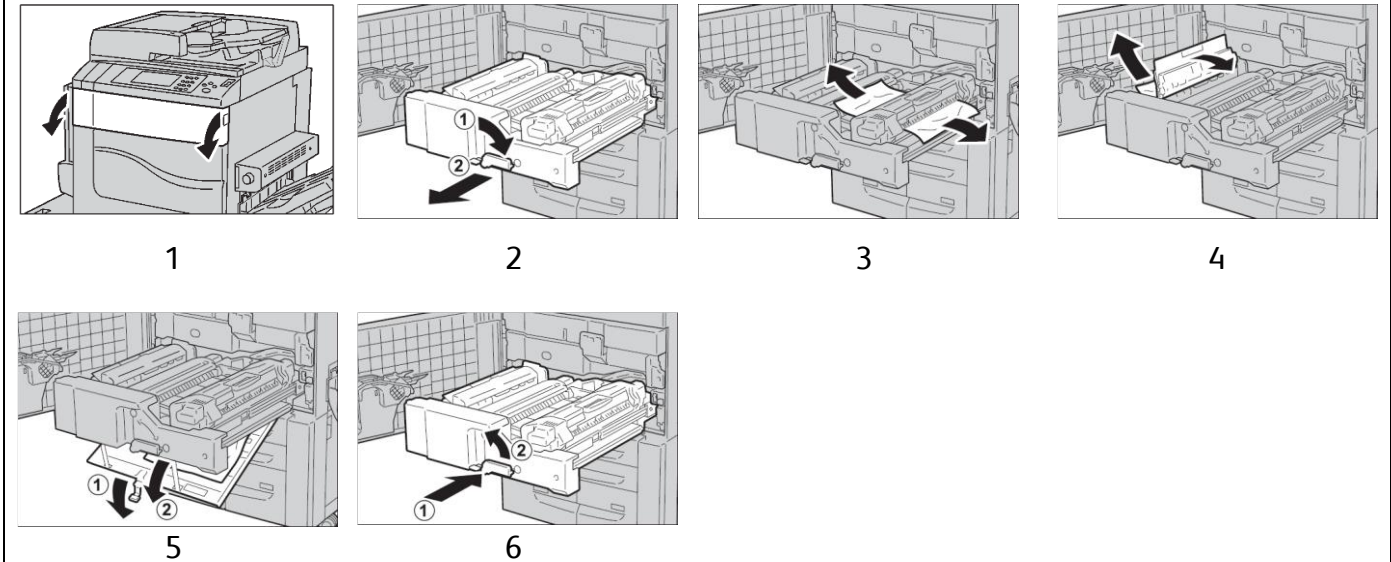

iv. Bottom Left Cover C / 左下蓋 C

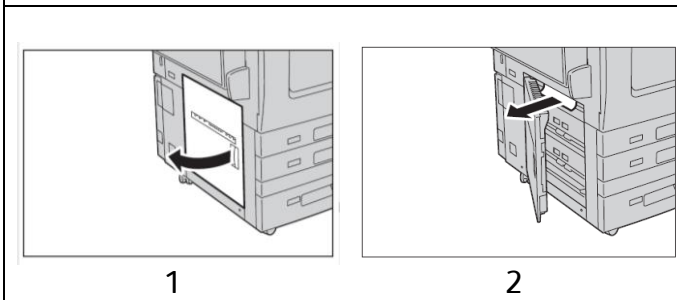

v. Bottom Left Cover C / 左下蓋 C

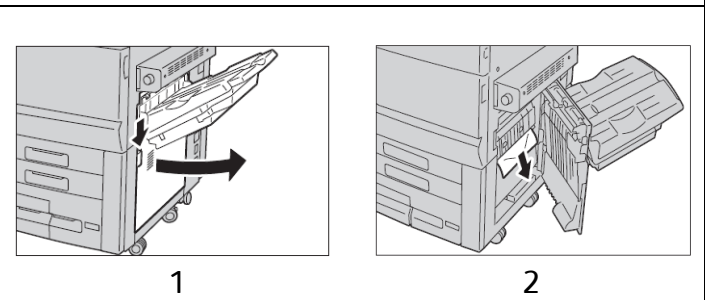

vi. C Finisher / 用 C 型裝訂檢集機

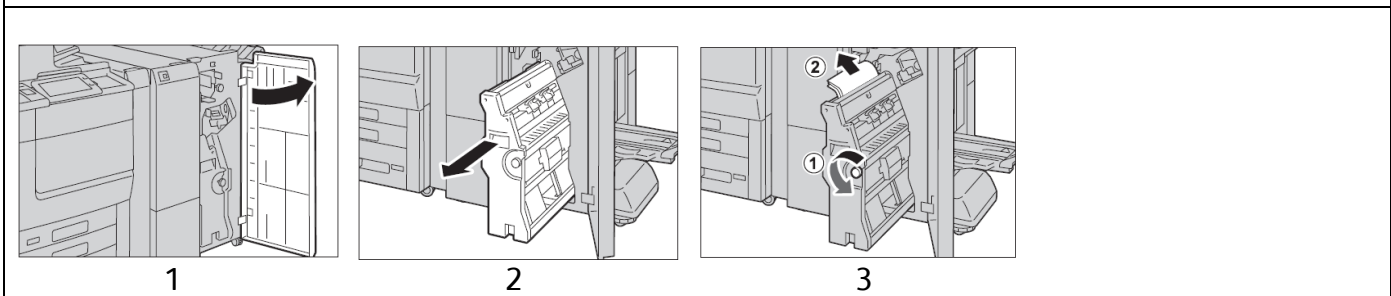

vii. Booklet Output Tray (For the Finisher C & D w/Booklet) / C & D 型裝訂檢集機出紙處

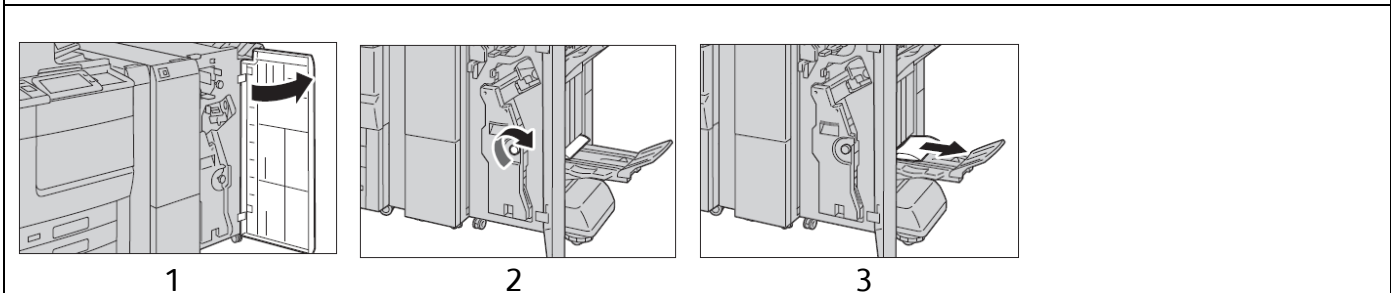

## 2 REPLACING TONER & WASTE TONER CONTAINER

### 更換碳粉匣及碳粉回收盒

#### i. Replacing Toner / 更換碳粉匣

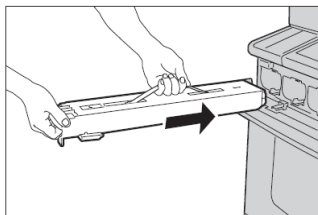
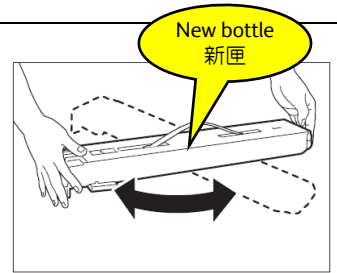
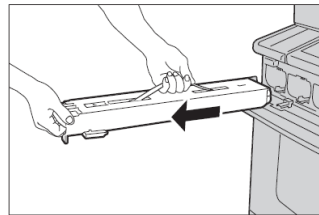
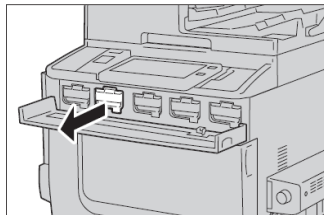
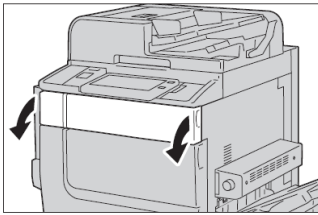

Scan QR Code OR Click [here](#) for online version of this chapter.

請掃描 QR Code 或者點擊 [這裡](#) 查看本章的網上版本

For more online support information please visit

更多相關資料，請訪問以下網址：

<https://support-fb.fujifilm.com>

#### ii. Replacing Waste Toner Container / 更換碳粉回收匣

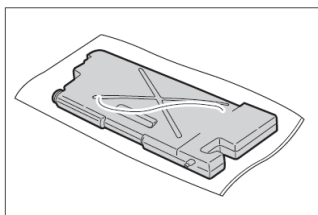
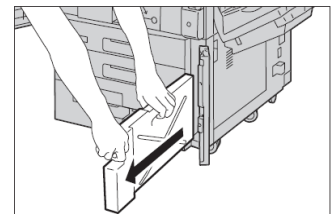
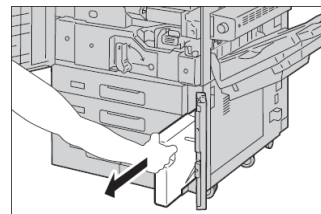
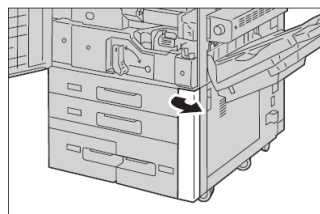
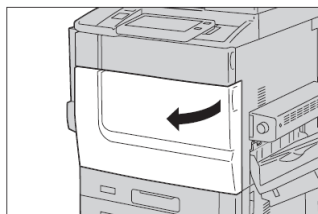

### 3 EXTRA INFORMATION 更多資訊



#### How to replace the drum cartridge

如何更換感光鼓

Scan QR Code OR Click [here](#)

請掃描 QR Code 或者點擊[這裡](#)



#### How to replace the R1 Finisher staple

如何更換 R1 裝訂器釘書釘

Scan QR Code OR Click [here](#)

請掃描 QR Code 或者點擊[這裡](#)

# **Customer Support Center**

## **2513-2513**

This document includes Fuji Xerox product(s), licensed from Xerox Corporation. The distributor of the product(s) is FUJIFILM Business Innovation Corp.  
Xerox, Xerox and Design, as well as Fuji Xerox and Design are registered trademarks or trademarks of Xerox Corporation in Japan and/or other countries.  
FUJIFILM and FUJIFILM logo are registered trademarks or trademarks of FUJIFILM Corporation.  
ApeosPort and DocuWorks are registered trademarks or trademarks of FUJIFILM Business Innovation Corp.